

2023







**martinelli luce**



Infinita 6  
Lunaop slim 28  
Wand 42

Multidot 12  
Dia 32  
Maggiolino 46

Avro 20  
Colibri tripode 38  
Jan 50

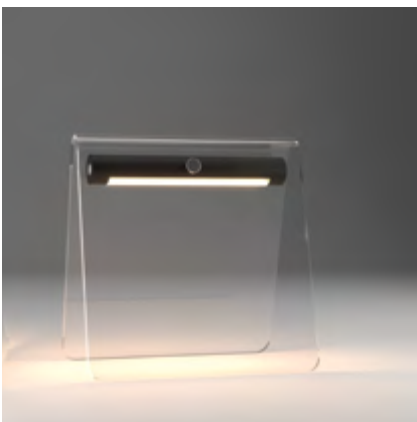



## INFINITA

Infinita, caratterizzata dall'intera composizione in vetro borosilicato, è una sospensione versatile che permette di dare vita a varie composizioni e soluzioni progettuali.

Il gioco di trasparenze innesca una magia di luce che affascina nel contrasto tra la sua essenza aerea, quasi inconsistente, e la forza della sua presenza.

Essendo realizzato parzialmente a mano ogni elemento che compone la lampada è unico.

Infinita, characterised by its entire composition in borosilicate glass, is a versatile suspension that allows several compositions and design solutions.

The transparencies trigger a charm of light that fascinates in the contrast between its airy essence, almost insubstantial, and the strength of its presence.

Being partially handmade, each element that makes up the lamp is unique.

MARTA SANSONI







# INFINITA

MARTA SANSONI



Un sistema componibile a sospensione a luce diffusa. Un profilo tubolare in vetro al borosilicato disponibile in 3 diverse lunghezze sostiene dei volumi tridimensionali (anch'essi in borosilicato: un cilindro, un disco, una semisfera, un romboide) tramite un O-ring in silicone trasparente che oltre a garantire la tenuta, funge da distanziatore.

Il sistema consente con l'utilizzo di specifici rosoni, la sospensione di 1-3-5-profili tubolari di diversa o uguale lunghezza (vedi esempi a lato). La scelta e il numero delle diverse forme geometriche è a discrezione del cliente.

Un supporto cilindrico in metallo verniciato, munito di cavo di alimentazione e di sorgente di luce a LED, da posizionare alla estremità superiore all'interno del tubo in vetro, ne permette tramite tre semplici pomelli il fissaggio.

Rosone a soffitto, completo di alimentatore, da ordinare secondo la composizione.

A modular suspension system with diffused light. A borosilicate tubular glass profile, available in 3 different lengths, supports the three-dimensional volumes (also in borosilicate, a cylinder, a disc, a hemisphere, a rhomboid) by means of a transparent silicone O-ring that not only guarantees the seal but also acts as a spacer.

The system allows the use with specific ceiling roses, to suspend 1-3-5 tubular profiles of different or equal lengths (see examples to the side)

The choice and the number of different geometric shapes is at the customer's discretion.

A cylindrical painted metal support, equipped with power cable, LED light source and to be positioned at the upper end inside the glass tube, allows it to be fixed by means of three knobs.

The ceiling rose includes the driver that has to be ordered according to chosen composition.

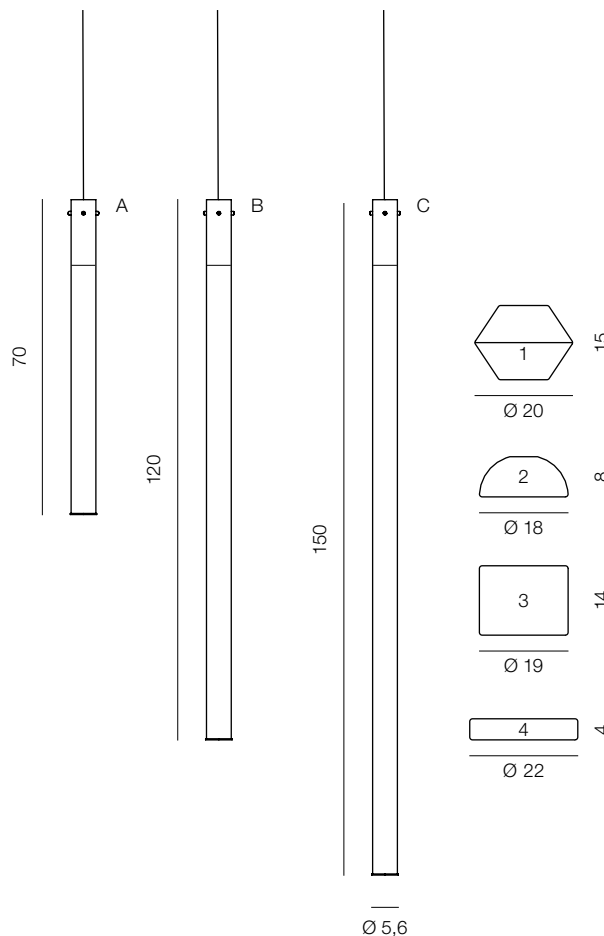

## TUBOLARI IN VETRO BOROSILICATO TUBULAR BOROSILICATE GLASS

9W LED 1080lm 2700K

tubolare / tubular 70 cm (A)

40199/70  vetro trasparente/transparent glass

tubolare / tubular 120 cm (B)

40199/120  vetro trasparente/transparent glass

tubolare / tubular 150 cm (C)

40199/150  vetro trasparente/transparent glass

## DIFFUSORI IN VETRO BOROSILICATO BOROSILICATE GLASS DIFFUSERS

Diffusore (1)

40200  vetro trasparente/transparent glass

Diffusore (2)

40201  vetro trasparente/transparent glass

Diffusore (3)

40202  vetro trasparente/transparent glass

Diffusore (4)

40203  vetro trasparente/transparent glass

La composizione delle lampade con 1 o più tubolari in vetro, numero e forma dei corpi geometrici è a scelta del cliente, consentendo la più ampia personalizzazione del progetto illuminotecnico.

The composition of the lamps with one or more glass tubulars, the number and shape of the geometric bodies is at the customer's discretion, allowing for the widest possible customisation of the lighting design.



Esempi di composizione con l'utilizzo dei tre rosone D-E-F  
Composition examples using the three ceiling roses

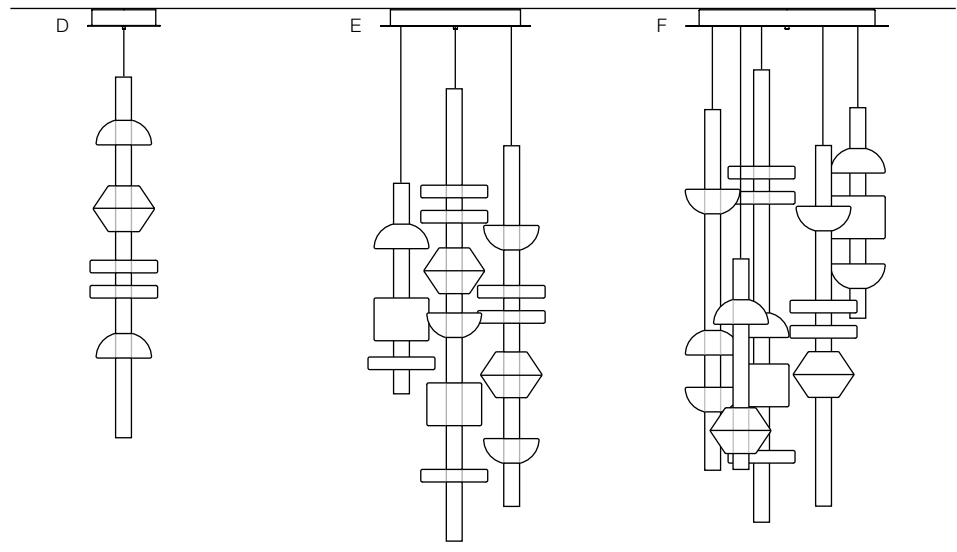

(D) rosone per 1 tubolare  
ceiling rose for 1 tubular

40206 10W

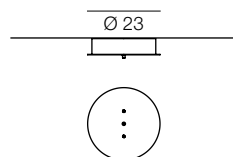

(E) rosone per 3 tubolari  
ceiling rose for 3 tubulars

40207 3X10W

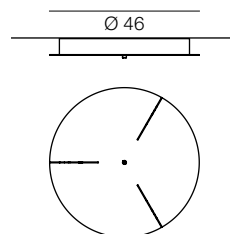

(F) rosone per 5 tubolari  
ceiling rose for 5 tubulars

40208 5X10W

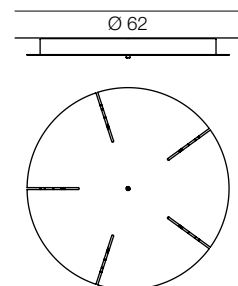



## MULTIDOT

Ispirandosi ai chandelier del passato, Multidot propone una interpretazione moderna del candelabro, dal punto di vista compositivo, espressivo e tecnologico, consentendo al progettista la massima personalizzazione e libertà creativa.

I cavi elettrici a basso voltaggio 24V che lo compongono a cui vengono agganciate le sfere luminose a LED, sono stati specificatamente progettati per diventare l'elemento strutturale e decorativo della lampada.

Multidot è estremamente flessibile e configurabile, valorizzando ogni ambiente.

Ogni cavo è fissato per una estremità al rosone al soffitto mentre l'altra estremità può essere posizionata liberamente al soffitto generando infinite composizioni nello spazio, sia regolari che randomiche.

Le composizioni si differenziano per il numero e la lunghezza dei cavi, oltre che per il numero di sfere luminose a LED.

Inspired by the chandeliers of the past, Multidot offers a modern interpretation of the chandelier, bringing it up to date in terms of composition, expression and technology, allowing the designer maximum customisation and creative freedom.

The low-voltage 24V electric cables have been specifically designed to become the structural, decorative and technological element of the lamp to which the LED light spheres are attached.

Multidot is extremely flexible and suitable for any environment. Each cable is fixed at one end to the ceiling rose and the other end can be freely positioned on the ceiling, generating infinite compositions in space, both regular and random.

The compositions differ in the number and length of cables, as well as the number of LED light spheres.

BRIAN SIRONI

EXAMPLES | SERIE S | cable 2,5m | 12 spheres each cable

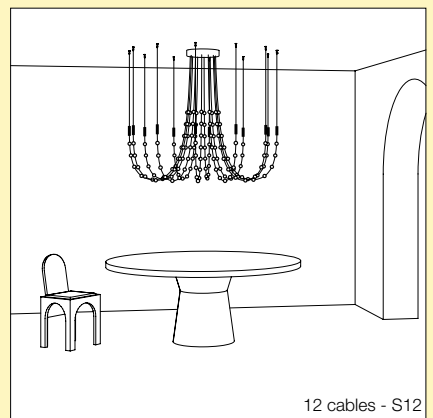
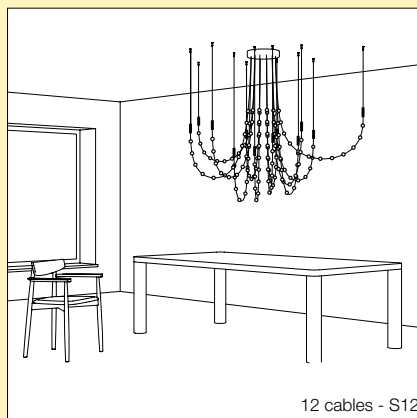
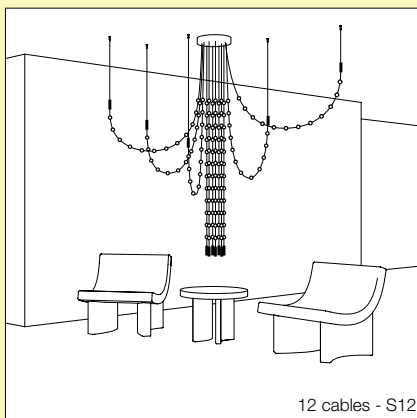
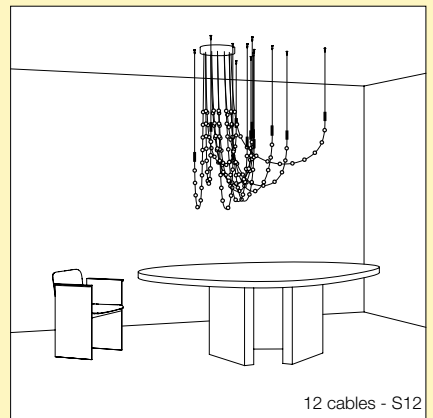
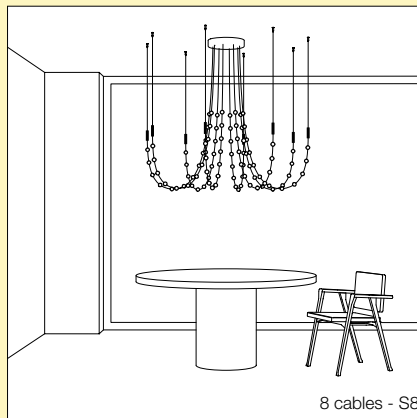
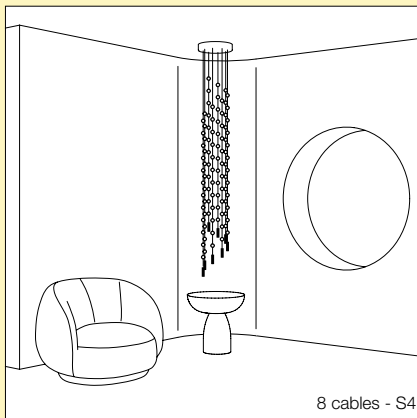
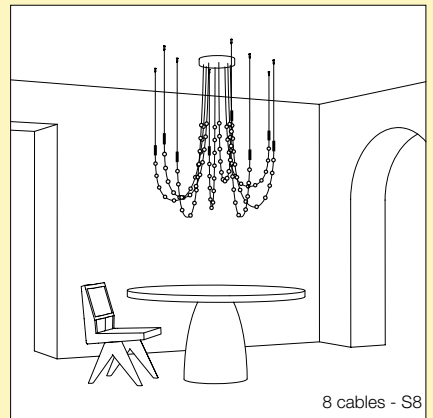
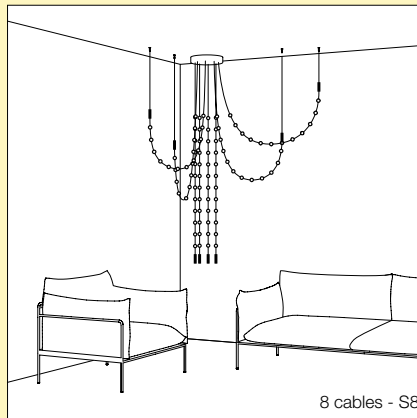
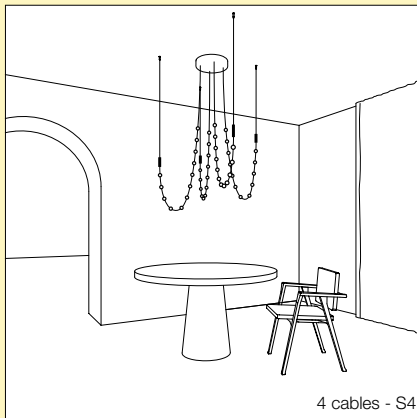
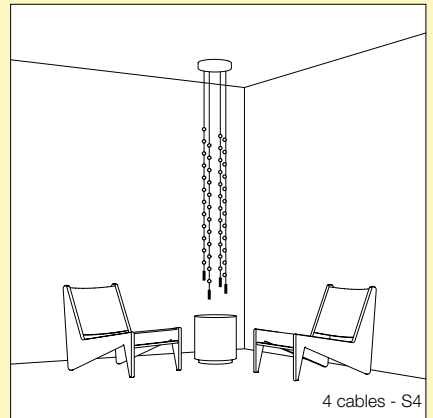
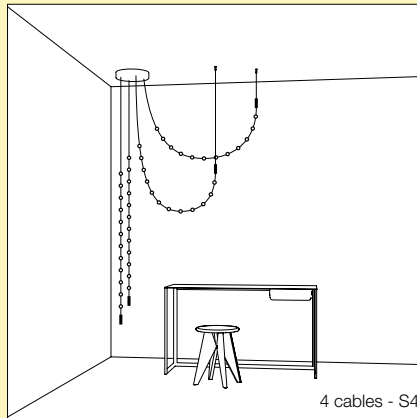
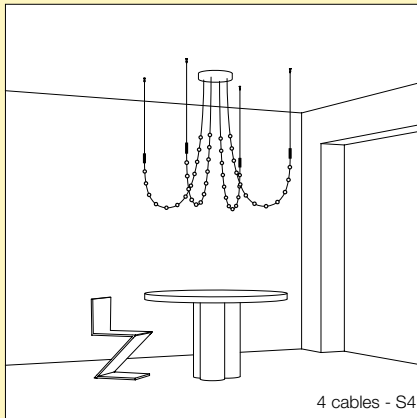
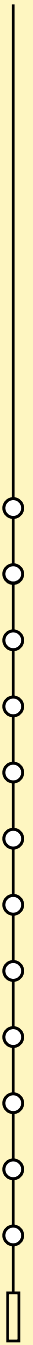



EXAMPLES | SERIE M | cable 3,5m | 16 spheres each cable

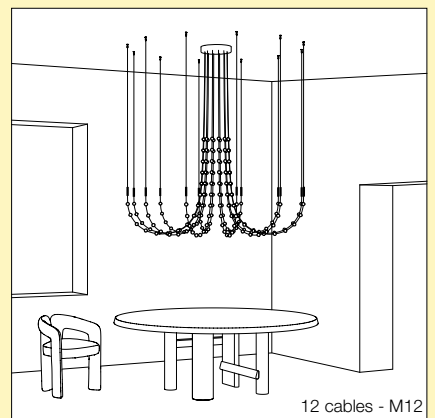
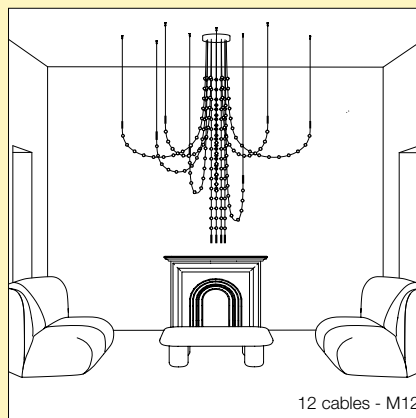
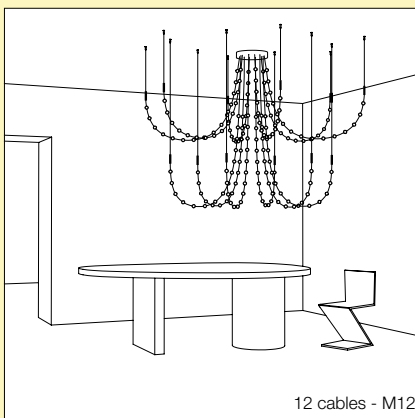
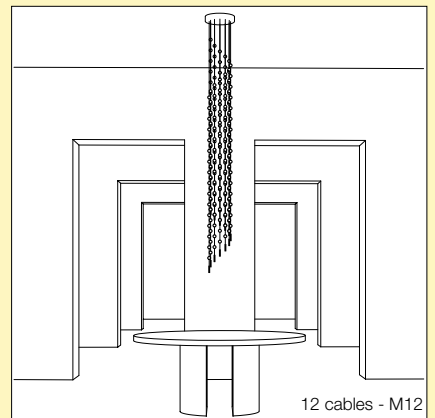
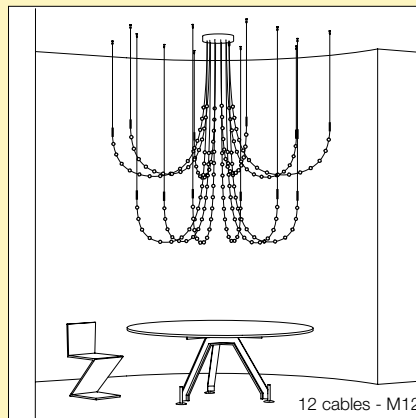
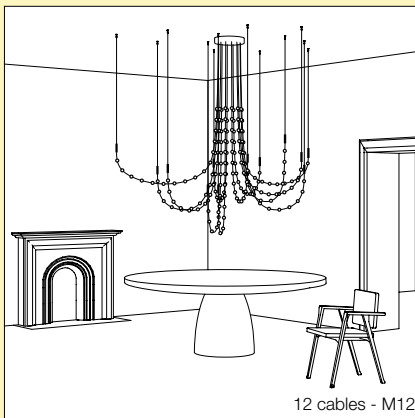
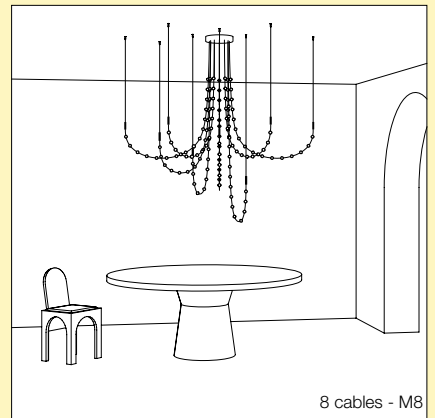
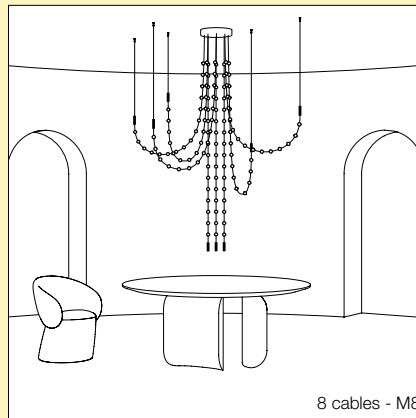
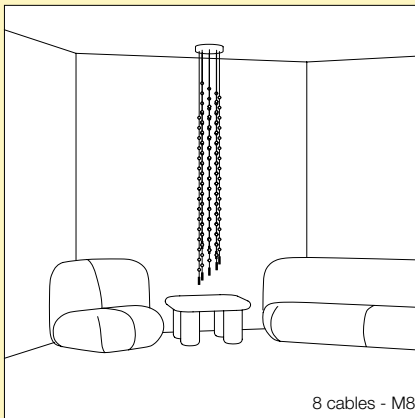
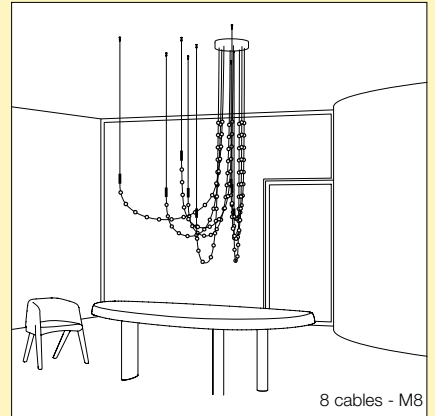
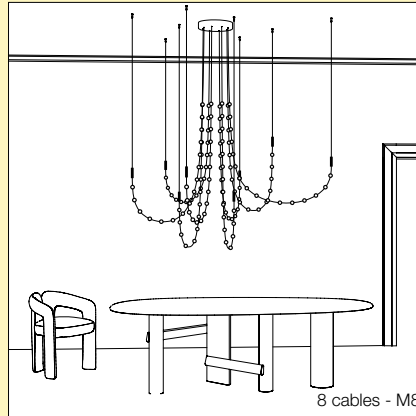
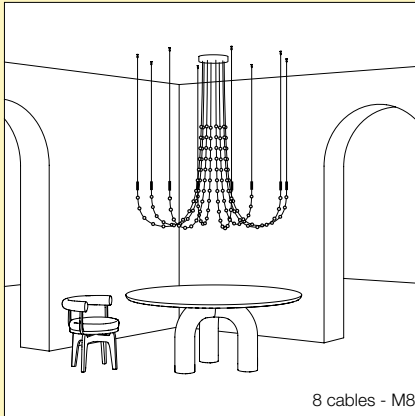





# MULTIDOT

BRIAN SIRONI



Lampada a sospensione a luce diffusa disponibile in diverse combinazioni. Formata da un numero variabile di cavi elettrici a 24V studiati appositamente, disponibili in due lunghezze (L 2,5 m / L3,5 m), su ciascun cavo sono fissate 12 (vedi serie S) o 16 (vedi serie M) sfere opaline con sorgente di luce a LED da 0,8W. Completa di rosone a soffitto cablato con alimentatore elettronico da 75W-max 200W secondo la composizione.

Pendant lamp with diffused light available in various combinations. Formed by a set of electric cables available in two lengths (L 2,5 m / L 3,5 m), to which 12 (see S series) or 16 (see M series) opal spheres complete with 24V 0.8W LED light sources are attached. Complete with ceiling rose wired with 75W-max 200W electronic driver depending on the composition.

## COMPOSIZIONI / COMPOSITIONS

### SERIE S

cavo / cable 2,5m

sfere per cavo / spheres per cable n°12

S4 | 4 cavi / cables 38W

21024/4/12/NE

S8 | 8 cavi / cables 77W

21024/8/12/NE

S12 | 12 cavi / cables 115W

21024/12/12/NE

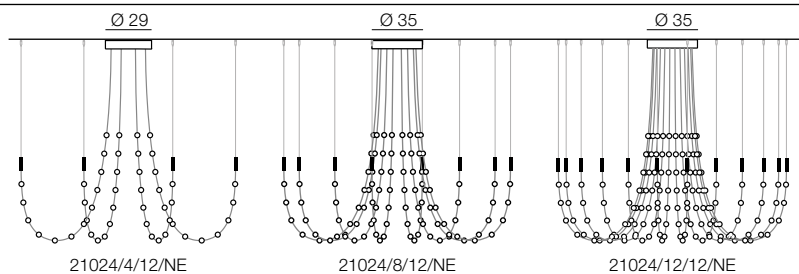

### SERIE M

cavo / cable 3,5m

sfere per cavo / spheres per cable n° 16

M8 | 8 cavi / cables 102W

21024/8/16/NE

M12 | 12 cavi / cables 154 W

21024/12/16/NE

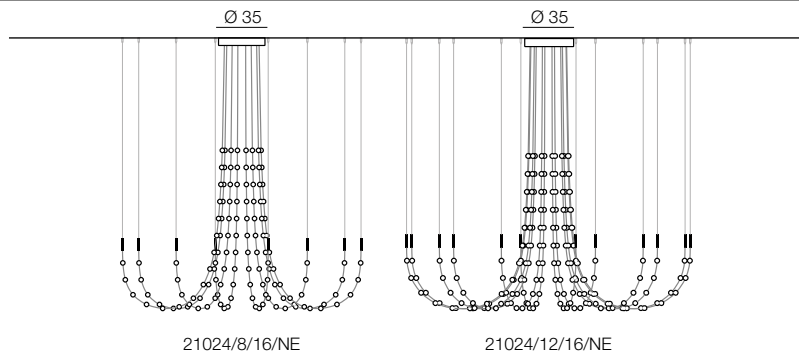

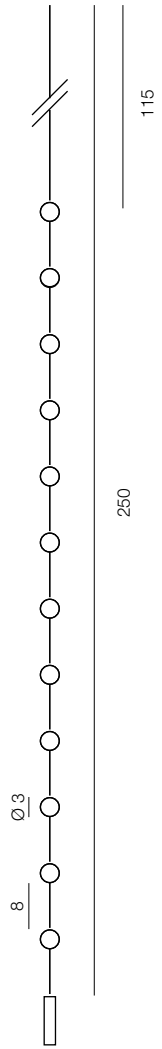

SERIE S

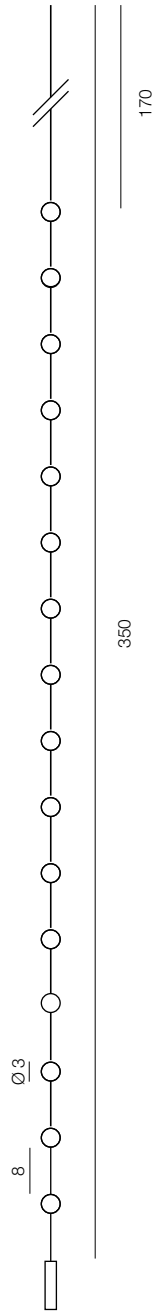

SERIE M



Esempi di composizione custom / Examples of custom composition

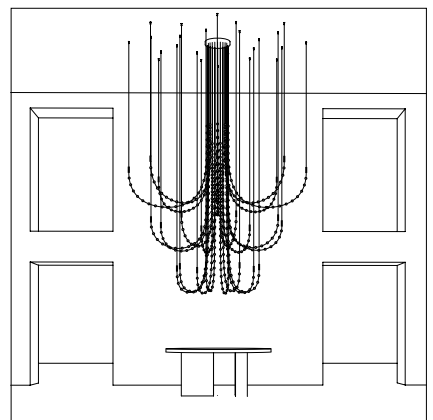
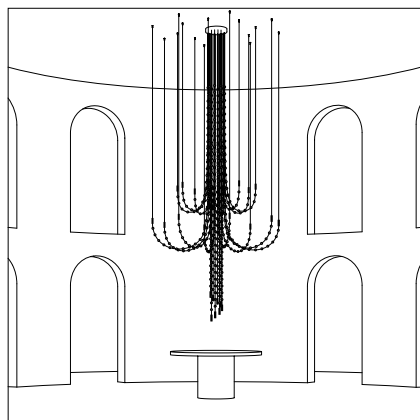



## AVRO

Grazie alla presa di corrente nella parte inferiore del suo diffusore, non sei più vincolato dalla disponibilità di una presa di corrente a parete. Con questo progetto Studio Natural ha voluto non solo semplificare l'attività lavorativa da casa, ma anche facilitare l'uso di dispositivi che necessitano di corrente elettrica, trasformando il tavolo da pranzo in una vera e propria officina culturale al servizio della creatività di chi la utilizza.

Con Avro la stagione di caccia alla presa elettrica è chiusa. Mangiare, lavorare o giocare sullo stesso tavolo non è più un problema. Ad ogni attività la sua luce, grazie al diverso grado di luminosità che ottieni giocando con la dimmerazione.

Il riflettore leggermente inclinato verso il basso ricorda le ali degli aerei Avro RJ-70, da cui la lampada prende il nome.

Avro è un sistema che comprende due dimensioni diverse della lampada, con la possibilità di attacco a soffitto con rosone o con attacco per binario elettrificato, oltre a un elemento singolo, sospeso, con la sola presa di alimentazione e con attacco per binario elettrificato.

Una lampada contemporanea ed innovativa.

Thanks to the power socket in the lower part of its diffuser, you are no longer obliged to have a wall socket. With this design, Studio Natural wanted not only to simplify working from home, but also to facilitate the use of devices that require electricity, transforming the dining table into a true cultural workshop at the service of the user's creativity. With Avro the season of hunting for an electrical socket is over. Eating, working or playing on the same table is no longer a problem. To each activity its own light thanks to the different degree of brightness you get by playing with the dimmer.

The slightly downward tilted reflector is reminiscent of the wings of the Avro RJ-70 aircraft from which the lamp takes its name.

Avro is a system that includes two different lamp sizes.

It can be ceiling mounted with a canopy or it can be installed on a track system thanks to its adapter. There's also a single pendant element (SONDA) that is just a socket, available for the track system.

A contemporary and innovative lamp.







Lampada a sospensione a luce diretta/diffusa con sorgente di luce LED dimmerabile. Caratteristica della lampada una presa schuko montata nel supporto inferiore al centro del diffusore in metacrilato opal bianco, per l'inserimento di una spina con cavo o di una multipresa. Struttura in alluminio verniciato nei colori bianco, nero, azzurro e arancio. Alimentatore elettronico dimmerabile all'interno del rosone di attacco al soffitto. Disponibile come accessorio alla lampada una multipresa da tavolo corredata di tre prese schuko 230V e di due USB, max potenza 2,3KW (vedi fig.1)

Direct/diffused light suspension lamp with dimmable LED source. The lamp features a schuko socket mounted in the lower support in the centre of the white opal methacrylate diffuser for inserting a plug with cable or a multi-socket. Painted aluminium structure in white, black, light blue and orange finish. The dimmable electronic driver inside the ceiling rose. The multi socket equipped with three 230V schuko socket and two USB outlets is available as a lamp accessory. Max power 2,3KW. (see fig.1)

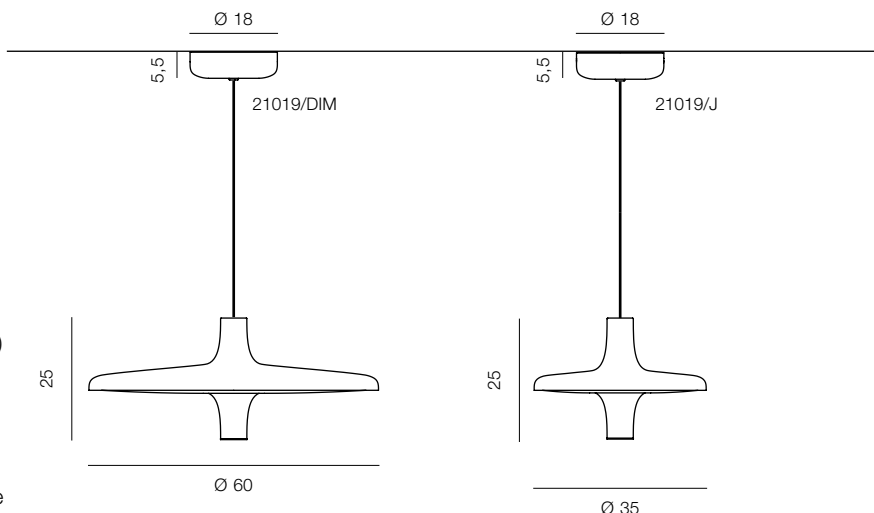

### AVRO



36W LED 5000lm 2700K

- 21019/DIM/BI ○ bianco/white
- 21019/DIM/NE ● nero/black
- 21019/DIM/AZ ● azzurro/light blue
- 21019/DIM/AR ● arancio/orange

36W LED 5000lm 3000K

- 21019/DIM/3000/BI ○ bianco/white
- 21019/DIM/3000/NE ● nero/black
- 21019/DIM/3000/AZ ● azzurro/light blue
- 21019/DIM/3000/AR ● arancio/orange

### DISPOSITIVO WIFI / WIFI DEVICE cod.40204

dispositivo WiFi Tuya per la dimmerazione delle lampade alimentate da 3 cavi per app e pulsante (escluso).

Tuya Wi-Fi dimming device for lamps powered by 3 cables for app and button (not included)

### DISPOSITIVO RF / RF DEVICE cod.40204.3

dispositivo dimmerabile in radio frequenza Tuya per la dimmerazione delle lampade alimentate da 3 cavi per pulsante (necessario)

Tuya radio frequency dimming device for lamps powered by 3 cables for push button (required)

### PULSANTE / BUTTON cod. 40209

### AVRO J

18W LED 2800lm 2700K

- 21019/J/BI ○ bianco/white
- 21019/J/NE ● nero/black
- 21019/J/AZ ● azzurro/light blue
- 21019/J/AR ● arancio/orange

18W LED 2800lm 3000K

- 21019/J/3000/BI ○ bianco/white
- 21019/J/3000/NE ● nero/black
- 21019/J/3000/AZ ● azzurro/light blue
- 21019/J/3000/AR ● arancio/orange

### DISPOSITIVO WIFI / WIFI DEVICE cod.40204.1

dispositivo WiFi Tuya per la dimmerazione per app e pulsante (escluso).

Tuya Wi-Fi dimming device for app and button (not included)

### DISPOSITIVO RF / RF DEVICE cod.40204.2

dispositivo dimmerabile in radio frequenza Tuya per pulsante (necessario)

Tuya radio frequency dimming device for push button (required)

### PULSANTE / BUTTON cod. 40209

### MULTIPRESA / MULTISOCKET

3 Schuko + 2 USB - Max 2,3KW

- 40189/BI ○ bianco/white
- 40189/NE ● nero/black
- 40189/GR ● grigio/grey
- 40189/AZ ● azzurro/light blue







# AVRO per binario elettrificato / for electrified track 230V



STUDIO NATURAL

Versione di Avro e Avro/J con adattatore per binario elettrificato 230V. In questa versione disponibile anche il particolare componente solo presa Avro/BE/SP, con un anello diffusore che si illumina quando alimentato per marcare la sua presenza. Struttura in alluminio verniciato.

Version of Avro and Avro/J with 230V electrified track adapter. It is also available the pendant “only-socket”, with a diffuser ring that lights up when powered to mark its presence. Painted aluminium structure.

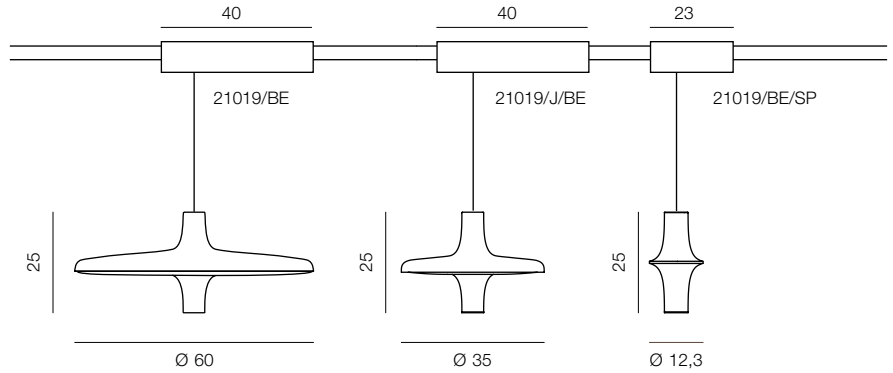

## AVRO BE | Electrified track 230V

36W LED 5000lm 2700K

- 21019/BE/BI ○ bianco/white
- 21019/BE/NE ● nero/black
- 21019/BE/AZ ● azzurro/light blue
- 21019/BE/AR ● arancio/orange

36W LED 5000lm 3000K

- 21019/BE/3000/BI ○ bianco/white
- 21019/BE/3000/NE ● nero/black
- 21019/BE/3000/AZ ● azzurro/light blue
- 21019/BE/3000/AR ● arancio/orange

## DISPOSITIVO WIFI / WIFI DEVICE cod.40204

dispositivo WiFi Tuya per la dimmerazione delle lampade alimentate da 3 cavi per app e pulsante (escluso).

Tuya Wi-Fi dimming device for lamps powered by 3 cables for app and button (not included)

## DISPOSITIVO RF / RF DEVICE cod.40204.3

dispositivo dimmerabile in radio frequenza Tuya per la dimmerazione delle lampade alimentate da 3 cavi per pulsante (necessario)

Tuya radio frequency dimming device for lamps powered by 3 cables for push button (required)

## PULSANTE / BUTTON cod. 40209

## AVRO J BE | Electrified track 230V

18W LED 2800lm 2700K

- 21019/J/BE/BI ○ bianco/white
- 21019/J/BE/NE ● nero/black
- 21019/J/BE/AZ ● azzurro/light blue
- 21019/J/BE/AR ● arancio/orange

18W LED 2800lm 3000K

- 21019/J/BE/3000/BI ○ bianco/white
- 21019/J/BE/3000/NE ● nero/black
- 21019/J/BE/3000/AZ ● azzurro/light blue
- 21019/J/BE/3000/AR ● arancio/orange

## DISPOSITIVO WIFI / WIFI DEVICE cod.40204.1

dispositivo WiFi Tuya per la dimmerazione per app e pulsante (escluso).

Tuya Wi-Fi dimming device for app and button (not included)

## DISPOSITIVO RF / RF DEVICE cod.40204.2

dispositivo dimmerabile in radio frequenza Tuya per pulsante (necessario)

Tuya radio frequency dimming device for push button (required)

## PULSANTE / BUTTON cod. 40209

## AVRO BE SP | solo presa / socket-only

- 21019/BE/SP/BI ○ bianco/white
- 21019/BE/SP/NE ● nero/black
- 21019/BE/SP/AZ ● azzurro/light blue
- 21019/BE/SP/AR ● arancio/orange

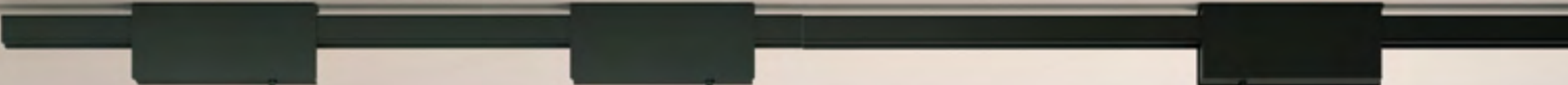



## LUNAOP slim

Un anello di luce sospeso in verticale, una nuova versione della Lunaop slim. La luce si diffonde dal diffusore centrale, mentre i tagli sulla circonferenza creano un effetto luminoso e caratterizzano la sospensione.

A vertically suspended ring of light, a new version of the Lunaop slim. The light diffuses from the central diffuser, while the cuts in the circumference let the light shine through and characterise the suspension.

EMILIANA MARTINELLI

# LUNAOP slim

EMILIANA MARTINELLI







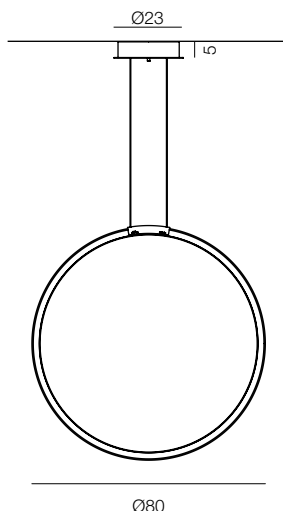

Lampada a sospensione a luce diffusa.  
Struttura con particolari tagli nell'anello in alluminio verniciato nei colori bianco, nero, oro perlato, rame, bronzo materico o ottone vintage.  
Diffusore in metacrilato opal bianco. Sospesa con i cavi di alimentazione da collegare al rosone da fissare al soffitto, completo di alimentatore elettronico.  
Sorgente di luce a LED integrata a 2700K, 3000K.

Suspension lamp with diffused light.  
Structure with special cuts in the aluminium ring painted in white, black, pearl gold, copper, rough bronze or vintage brass finish.  
White opal methacrylate diffuser.  
Suspended with the power cables to be connected to the ceiling rose that includes the driver.  
Integrated LED light source (2700k or 3000K).



## ANELLO / RING

33W LED 5620lm 2700K







40193/BI		bianco/white
40193/NE		nero/black
40193/AU		oro perlato/pearly gold
40193/CU		rame/copper
40193/BM		bronzo materico/rough bronze
40193/OV		ottone vintage/vintage brass

33W LED 5620lm 3000K

40193/3000/BI		bianco/white
40193/3000/NE		nero/black
40193/3000/AU		oro perlato/pearly gold
40193/3000/CU		rame/copper
40193/3000/BM		bronzo materico/rough bronze
40193/3000/OV		ottone vintage/vintage brass







## ROSONE / CEILING ROSE

Rosone non dimmerabile 75W per dispositivi Tuya  
Non dimmable ceiling rose 75W for Tuya device

40194/BI		bianco/white
40194/NE		nero/black
40194/AU		oro perlato/pearly gold
40194/CU		rame/copper
40194/BM		bronzo materico/rough bronze
40194/OV		ottone vintage/vintage brass

Rosone dimmerabile 75W  
Dimmable ceiling rose 75W



40195/BI		bianco/white
40195/NE		nero/black
40195/AU		oro perlato/pearly gold
40195/CU		rame/copper
40195/BM		bronzo materico/rough bronze
40195/OV		ottone vintage/vintage brass

DISPOSITIVO WIFI / WIFI DEVICE cod.40204.1  
dispositivo WiFi Tuya per la dimmerazione per app e pulsante (escluso).  
Tuya Wi-Fi dimming device for app and button (not included)

DISPOSITIVO RF / RF DEVICE cod.40204.2  
dispositivo dimmerabile in radio frequenza Tuya per pulsante (necessario)  
Tuya radio frequency dimming device for push button (required)

PULSANTE / BUTTON cod. 40209







## DIA

Oltre che lampada da terra la famiglia Dia si amplia con due nuove versioni a sospensione.

Una versione a sola luce diretta ed una a luce diretta indiretta. Corpo tubolare in vetro borosilicato trasparente come nella versione da terra.

In addition to the floor lamp, the collection Dia will include two new pendant versions.

A version with direct light only and a version with indirect/direct light with a tubular transparent borosilicate glass body as in the floor version.

SIMON SCHMITZ

# DIA

SIMON SCHMITZ



Lampada da terra a luce diretta e indiretta e con doppia accensione tramite l'interruttore sul corpo lampada.

Diffusore tubolare di sostegno in vetro borosilicato trasparente. Dissipatore in alluminio e cavi di alimentazione a vista di colore rosso all'interno del tubolare.

Sorgente di luce a LED.

Alimentatore a spina.

Floor lamp with dual direct and indirect lighting, using the switch on the lamp body.

Tubular supporting diffuser in transparent borosilicate glass. Aluminium heat sink and visible red colour power cables inside the tubular support.

LED light source.

Plug-in power supply.

9W LED 1060lm 2700K

luce diretta / direct light

+

9W LED 1060lm 2700K

luce indiretta / indirect light

2317  trasparente / transparent

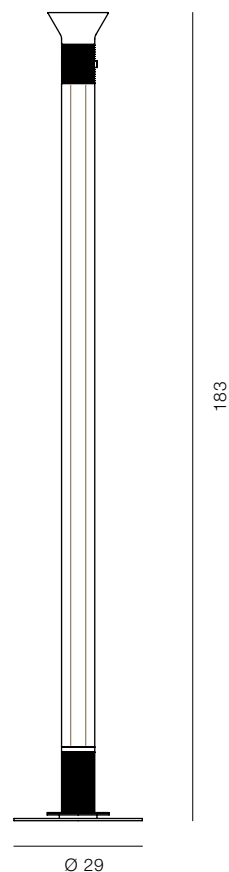



# DIA

SIMON SCHMITZ



Lampada a sospensione nelle versioni a luce diretta e a luce diretta/indiretta.  
Struttura e diffusore in vetro borosilicato trasparente, dissipatore in alluminio e cavi di alimentazione a vista.  
Sorgente di luce a LED.  
Alimentatore nel rosone cilindrico a soffitto.

Suspension lamp available with direct light and direct/indirect light.  
Transparent borosilicate glass frame and diffuser, aluminium heat sink and visible power cables.  
Led light source.  
Driver included in the cylindrical ceiling rose.

DIA luce diretta  
DIA direct light

9W LED 1350lm 2700K

21023  trasparente/transparent

DIA luce diretta/indiretta  
DIA direct/indirect light

9W LED 1060lm 2700K

luce diretta/direct light

+

9W LED 1060lm 2700K

luce indiretta/indirect light

21023/50  trasparente/transparent

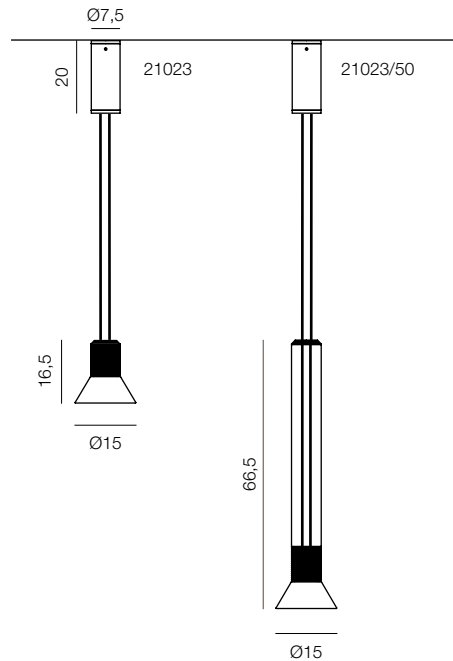





## COLIBRÌ tripode

Esteticamente essenziale e minimalista, Colibrì Tripode si integra in qualsiasi tipo di arredamento, indifferente al tempo e alle mode del momento.

Colibrì Tripode è una lampada da terra caratterizzata da due elementi di forma cilindrica, funzionali che supportano le sorgenti luminose.

Grazie alla possibilità di ruotare separatamente le fonti luminose, orientandole verso terra, parete o soffitto, la lampada è un esempio di versatilità.

Aesthetically essential and minimalist, Colibrì Tripode blends into any type of interior, being timeless and immune to passing fashions.

Colibrì Tripode is a floor lamp characterised by two cylindrically shaped functional elements that support the light sources.

Thanks to the possibility of rotating the light sources separately, adjusting them towards the floor, wall or ceiling, the lamp is an example of versatility.

MARCO PISATI, EMILIANA MARTINELLI

# COLIBRÌ tripode

MARCO PISATI, EMILIANA MARTINELLI



Lampada da terra a treppiedi a luce orientabile diffusa diretta/indiretta, con rotazione indipendente dei due bracci laterali.  
Struttura in tubolare di alluminio verniciato.  
Sorgenti di luce a LED integrate.  
Alimentatore elettronico a spina.

Tripod floor lamp providing diffused direct/indirect light, adjustable, with independent rotation of the two side arms.  
Tubular painted aluminium structure.  
Integrated led light sources.  
Electronic plug-in supply.

2x10W LED 2x1115lm 2700K

2320/NE ● nero/black

2320/GI ● giallo/yellow

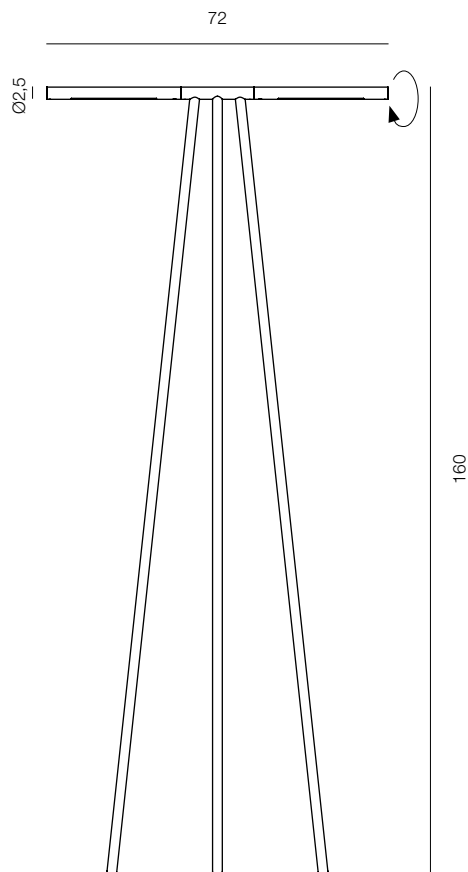





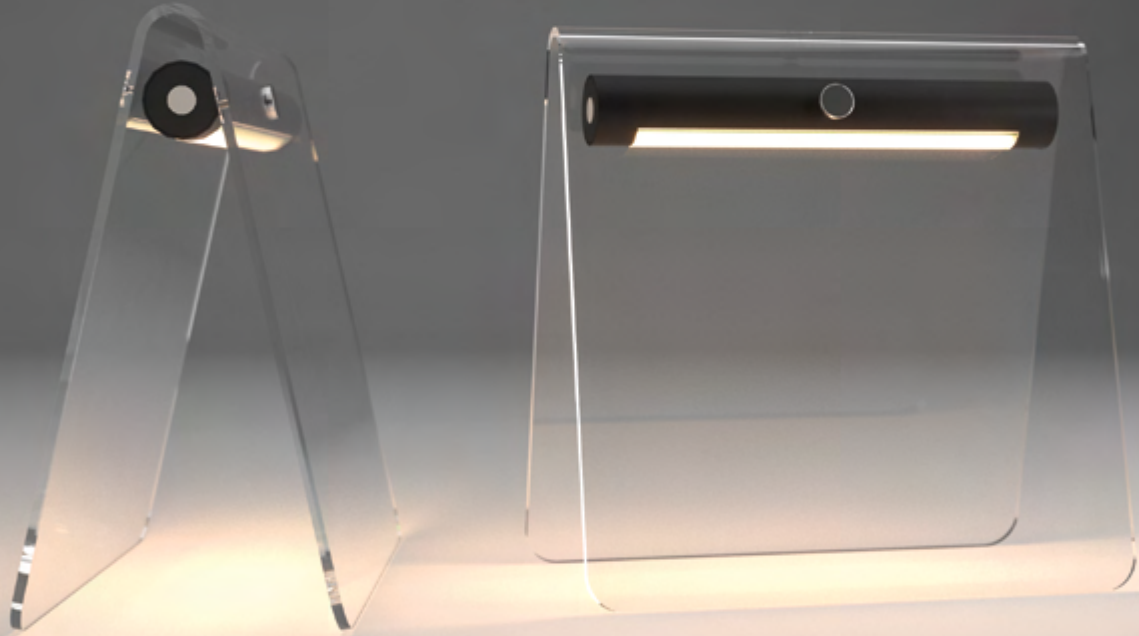

## WAND

Wand è una lampada da tavolo portatile cordless, che puoi utilizzare in vari ambienti e situazioni.

Il supporto in metacrilato trasparente sorregge la fonte luminosa e caratterizza questa lampada.

Il corpo cilindrico completo di due batterie ne permette l'utilizzo, libero da cavi, sia nell'ambiente domestico che in bar e ristoranti oltre che per eventi sia all'aperto che al chiuso. Wand ha un'autonomia funzionale di circa 6 ore di utilizzo.

Wand is a cordless portable table lamp that can be used in various environments and situations.

The transparent methacrylate stand supports the light source and characterises this lamp.

The cylindrical body has two batteries, free of cables, to be used at home as well as in bars and restaurants and for both outdoor and indoor events. Wand has a functional autonomy of approximately 6 hours of use.

BELLUCCI MAZZONI PROGETTI

# WAND

BELLUCCI MAZZONI PROGETTI



Lampada cordless da tavolo a luce diretta diffusa. Wand è una lampada formata da una struttura in metacrilato trasparente che supporta il tubolare in alluminio verniciato completo di sorgente di luce a LED e di batterie ricaricabili con ingresso USB-C. Autonomia di utilizzo di circa 6 ore. Caricabatterie non incluso.

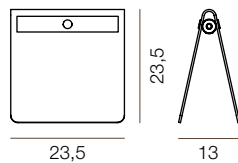

Cordless table lamp with direct light. Wand is a lamp consisting of a transparent methacrylate structure supporting a painted aluminium tube complete with LED light source and rechargeable batteries with USB-C input. Autonomy of use of approximately 6 hours. Battery charger not included.

1,5W LED 2700K

837/NE ● nero/black





## MAGGIOLINO

Una piccola lampada da soffitto che puoi personalizzare scegliendo la forma di lampadina che più è in tono con l'ambiente ed il tuo umore, quella che più ti ispira, che potrai cambiare semplicemente scegliendone un'altra. Il corpo in alluminio che supporta il portalampada è stato studiato per creare un giocoso abbinamento con le tre lampadine a disposizione: a sfera, a disco, a cono.

A small ceiling lamp that you can customise by choosing the shape of bulb that best suits your environment and your mood, the one that inspires you most, which you can change by simply choosing another one. The aluminium body that supports the lamp holder has been designed to create a playful combination with the three bulbs available: sphere, disc, cone.

EMILIANA MARTINELLI

# MAGGIOLINO

EMILIANA MARTINELLI



Lampada da soffitto a luce diretta diffusa formata da un supporto in alluminio verniciato e da una lampadina a LED da scegliere a piacere tra le tre forme da noi suggerite.

Ceiling lamp providing diffused direct light consisting of a painted aluminium support and an LED bulb to be chosen at will from our three suggested shapes.

## SUPPORTO / SUPPORT

6W 230V E27 LED

- 2906/BI  bianco/white
- 2906/AR  arancio/orange
- 2906/BZ  bronzo/bronze

## LAMPADINE / BULBS

- 583Y 6W E27 LED 540lm 2700K (1)
- 584Y 6W E27 LED 600lm 2700K (2)
- 585Y 6W E27 LED 580lm 2700K (3)

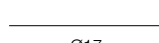
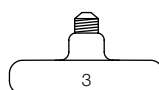
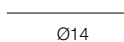
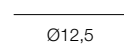
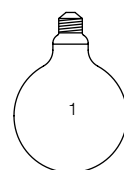
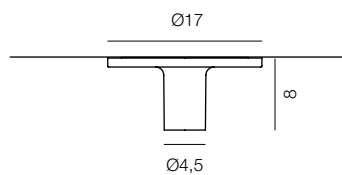







## JAN

Lampada da esterno a luce diretta e diffusa. Un esercizio di sottrazione in cui il disegno minimale e geometrico si concentra per ottenere un effetto di luce emozionale che fuoriesce dal foro centrale.

Jan oltre che fonte di luce è anche una seduta per il tuo giardino.

Jan è realizzata in cemento, caratterizzato dalla graniglia in marmo di recupero.

Outdoor lamp providing direct and diffused light. An exercise in subtraction in which the minimalist and geometric design is concentrated to achieve an emotional light effect that emanates from the central hole.

Jan is not only a source of light but also a seat for your garden.

Jan is made of concrete, characterised by reclaimed marble grit.

ANTONIO DE MARCO

# JAN

ANTONIO DE MARCO



Lampada da esterno a luce diretta diffusa, con base da fissare a terra sul pozzetto. Struttura in cemento grigio con inglobata graniglia di marmo di recupero in evidenza solo sulla parte perimetrale della lampada. Ogni pezzo è realizzato e rifinito individualmente. Per sorgente di luce a LED.

Outdoor lamp providing diffused direct light, with base to be fixed to the ground on the cockpit. Grey cement structure with reclaimed marble grit incorporated only on the perimeter part of the lamp. Each piece is individually made and finished. For LED light source.

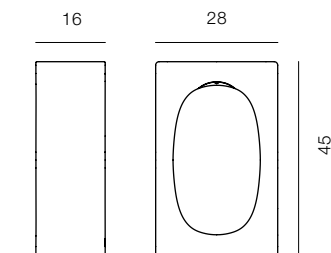

6W LED 600lm 2700K

Cemento con graniglia di marmo bianco Carrara  
Concrete with white Carrara marble grit

2321/GR/MAR/BI  grigio/white

---

Solo cemento/Only concrete

2321/GR  grigio cemento  
concrete grey







Su richiesta versione con graniglia di marmo nero ebano (minimo 10 pezzi)

Version with ebony black marble grit on request (minimum 10 pieces)





TIPOLOGIA DI LAMPADA  
LAMPS TYPOLOGY

-  lampade sospensione  
suspension lamps
-  lampade da terra  
standing lamps
-  lampade da parete  
wall lamps
-  lampade da soffitto  
ceiling lamps
-  lampade per binario elettrificato  
electrified track lamps
-  cordless

EMISSIONE DI LUCE  
LIGHT EMISSION

-  luce diretta  
direct light
-  luce indiretta  
indirect light
-  luce diretta indiretta  
direct indirect light
-  luce diffusa  
diffused light
-  luce orientabile  
swiveling light
-  dimmerabile  
dimmable
-  dispositivi Tuya per la dimmerazione  
Tuya dimming devices



**MARTINELLI LUCE** si riserva il diritto di apportare ai propri modelli in ogni momento senza nessun preavviso, qualsiasi modifica ritenesse opportuna.

**MARTINELLI LUCE** reserves the right to introduce any changes to its own models, without prior notice.



